

OX LINE



cmatic[®]
PNEUMATIC FITTINGS

Raccordi a Ogiva in Acciaio Inox 316L
316L Stainless Steel Compression Fittings
Raccords à bague en Acier Inox 316L
Schneidringverschraubungen aus Edelstahl 1.4404



I

I Raccordi ad Ogiva della serie OX sono realizzati completamente in Acciaio Inox AISI 316L (1.4404) e permettono la connessione di tubi in Acciaio.

La connessione con il tubo è semplice, non necessita l'utilizzo di grassi e ciò consente al raccordo di mantenere la caratteristica di prodotto food-grade.

Le sedi delle ogive, le ogive ed i dadi sono dimensionati seguendo le prescrizioni della normativa ISO8434/DIN 2353.

GB

The OX fittings are completely made in AISI 316L (1.4404) and they are suitable for assembly with stainless steel pipes. The pipe connection is easy and needs no grease, allowing thereby to keep the food grade degree of the product. The olive seat, the olives and the nuts are all manufactured according to ISO8434/DIN 2353 norm.

F

Les raccords à bague de la série OX sont fait entièrement en acier inox AISI 316 L (1.4404) et conçus pour le montage avec tuyaux en acier. Le montage avec le tuyau est très simple et surtout ne nécessite pas de graisse ainsi que le raccord maintient le degré de produit de qualité alimentaire. Le siège de la bague, la bague et l'écrou sont produits selon la norme ISO 8434/DIN2353.

D

Die Schneidringverschraubungen der OX Baureihe sind aus Edelstahl 316L (1.4404) und ermöglichen die Verbindung mit Stahlrohren. Die Montage ist sehr einfach und erfordert keinen Fettsatz; damit behält die Verschraubung die Lebensmittelqualitätsstufe. Das Schneidringgehäuse, der Schneidring und die Überwurfmutter werden gemäß der ISO8434/DIN 2353 hergestellt.

1	2	3
Corpo Body Corps Körper	Dado Nut Écrou Überwurfmutter	Ogiva Olive Bague Schneidring
Acciaio Inox AISI 316L (1.4404) Stainless Steel AISI 316L (1.4404) Acier Inox AISI 316L (1.4404) Edelstahl AISI 316L (1.4404)	Acciaio Inox AISI 316L (1.4404) Stainless Steel AISI 316L (1.4404) Acier Inox AISI 316L (1.4404) Edelstahl AISI 316L (1.4404)	Acciaio Inox AISI 316L (1.4404) Stainless Steel AISI 316L (1.4404) Acier Inox AISI 316L (1.4404) Edelstahl AISI 316L (1.4404)



-40°C + 250°C



Max 80 bar



	R1/8	R1/4	R3/8	R1/2
4	●			
6	●	●		
8	●	●		
10		●	●	
12			●	●

SPECIFICHE TECNICHE

Tubi di collegamento consigliati:
Tubi in Acciaio Inox senza saldatura secondo
normativa DIN EN 10216-5
Tolleranze accettabili sui tubi:
Secondo normativa DIN EN 10216-5

Campi di applicazione:
Industria alimentare, farmaceutica e
strumentazione.

DATA SHEET

Recommended pipes:
Seamless Stainless steel pipes according
to the DIN EN 10216-5 Norm
Acceptable hoses tolerances:
According to DIN EN 10216-5

Application fields:
Food and Pharma industry and
instrumentation

REINSEIGNEMENTS TECHNIQUES

Tubes conseillés:
Tubes sans soudures selon la norme
DIN EN 10216-5
Tolérances permises:
Selon la norme DIN EN 10216-5

Domaines d'emploi:
Alimentaire, pharma et instrumentation

TECHNISCHE AUSKÜNFTE

Empfohlene Röhre:
Nahtlose Röhre gemäß DIN EN 10216-5
Angenommene Rohrtoleranzen:
Gemäß DIN EN 10216-5

Anwendungsbereiche:
Nahrungsmittel, Pharma und Messung

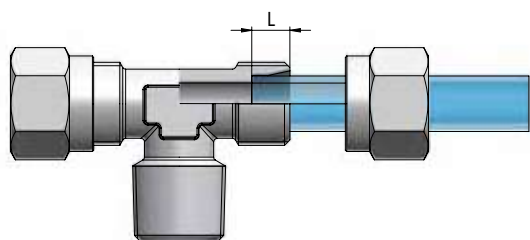

Ø Tube	L
4	4
6	5,5
8	5,5
10	7
12	7

PREPARAZIONE TUBO E AVVERTENZE

La lunghezza minima L del tubo montato tra 2 raccordi deve essere almeno 2,5+3 volte l'altezza del dado utilizzato per il serraggio. Nel caso occorra collegare al raccordo tubi curvi, assicurarsi che la curvatura del tubo sia ad una distanza H almeno pari al doppio dell'altezza del dado.

Tubo

Le estremità dei tubi smontate vanno montate nello stesso raccordo usato per il serraggio.

Per il taglio dei tubi NON utilizzare un tube cutter ma un seghetto tradizionale che favorisce un taglio in squadra e limita la formazione di bave.

PIPE PREPARATION AND WARNINGS

The min. pipe length "L" between two fittings has to be at least 2.5-3 times the nut height.

To connect a curved pipe, make sure the pipe curve be at least at a distance "H" equaling twice the nut height.

Pipe

If disassembled, the pipe endings have to be re-assembled in the same fitting shoulder as previously used.

To cut the tube, DO NOT use a pipe cutter but a saw that allows for a square cut and limits burrs.

PREPARATION DU TUBE

La longueur min. " L" du tube assemblé entre deux raccords doit correspondre au moins à 2,5-3 fois l'hauteur de l'écrou. Pour connecter un tube coudé, vérifier que la courbure du tube soit à une distance "H" au moins égale à deux fois l'hauteur de l'écrou.

Tube

Une fois démonté, le tube devra être monté dans le même raccords employé avant.

Pour couper le tube, ne pas utiliser un coupe tube mais une scie traditionnelle, qui permet une coupe à angle droit et limite les bavures.

ROHRVORBEREITUNG

Die Rohrlänge zwischen zwei Verschraubungen muss mindestens 2,5-3 Mal der Überwurfmutterhöhe entsprechen. Beim Einsatz von Winkelrohren, muss die Rohrkrümmung mindestens zweimal die Überwurfmutterhöhe entfernt sein (H).

Rohr

Wenn demontiert, muss die Rohrende in das gleiche Verschraubungsgehäuse wie zuvor, montiert werden.

Rohren dürfen mit keinem Rohrschneider sondern mit einer traditionellen Säge abgesägt werden, die einen rechtwinkligen Schnitt ermöglicht und eventuelle Gratbildung beschränkt.

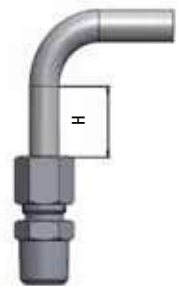

Ø Tube	Ø 4	Ø 6	Ø 8	Ø 10	Ø 12
H min.	22	23	24	31	31
L min.	33	34	36	46	46

ISTRUZIONE DI MONTAGGIO

1. Tagliare il tubo ad angolo retto rispetto all'asse del tubo stesso. E' ammesso uno scostamento massimo di 0.5° rispetto all'asse del tubo.
2. Sbavare il tubo sul bordo interno ed esterno facendo attenzione a non rovinare il piano d'appoggio.
3. Infilare il dado e l'ogiva sul tubo facendo attenzione a montare l'ogiva con il dentino di aggraffaggio rivolto verso l'estremità del tubo da serrare.
4. Inserire il tubo nell'apposita sede del corpo portandolo fino alla battuta prevista, assicurandosi che il corpo, il dado e il tubo siano in asse tra loro.
5. Serrare manualmente il dado fino al totale avvvitamento.

**ASSEMBLY INSTRUCTIONS**

1. Cut the pipe square. A max 0.5° deviation to the pipe axis is allowed
2. Deburr the pipe internally and externally, making sure not to damage the pipe edge.
3. Slide the nut and the ferrule on the pipe. Make sure the ferrule cutting edge is facing the pipe ending.
4. Insert the pipe into the fitting against the shoulder. All components have to be in axis.
5. Tighten the nut manually all the way down.

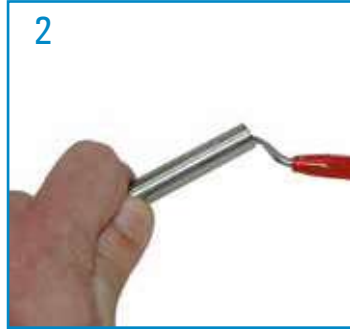
**INSTRUCTIONS POUR L'INSTALLATION**

1. Couper le tube à angle droit par rapport à l'axe du tube même. Un écart maxi de 0,5° est permis.
2. Ebavurer le tube à l'intérieur et à l'extérieur sans endommager le plan d'appui.
3. Glisser l'écrou et la bague sur le tube. Le coté coupante de la bague doit être positionnée vers l'extrémité du tube.
4. Insérer le tube dans le siège du raccords jusqu' au fond et s'assurer que le corps, l'écrou et le tube soient dans axe.
5. Visser à la main jusqu'au fond.

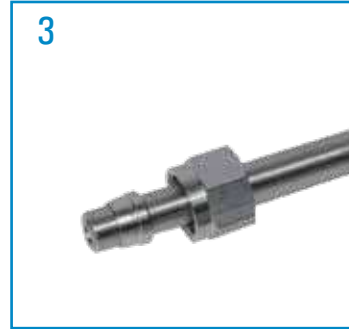
**MONTAGEANWEISUNGEN**

1. Das Rohr rechtwinkelig zum Achse absägen. Eine Maximal Abweichung von 0.5° zu dem Rohrachse ist genehmigt.
2. Rohr innen und außen entgraten ohne die Rohrfläche dabei zu beschädigen.
3. Überwurfmutter und Schneidring auf das Rohr schieben. Der Schneidring muss in der Richtung des Rohrendes sein.
4. Rohr in das Verschraubungsgehäuse bis zum Anschlag einstecken. Der Körper, der Schneidring und die Überwurfmutter müssen alle in Achse sein.
5. Überwurfmutter manuell festziehen.

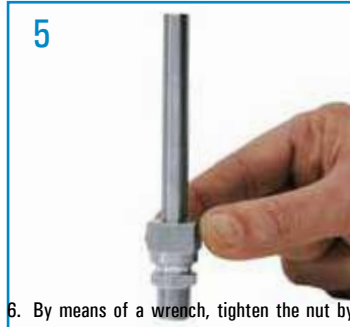
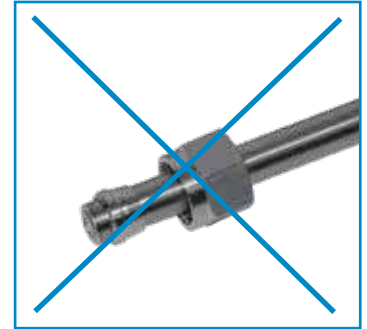

Ø Tube	Nm
Ø 4	10
Ø 6	20
Ø 8	25
Ø 10	30
Ø 12	65

6. Con l'ausilio di una chiave effettuare il serraggio finale del dado sul tubo avvitandolo di circa ¼ -1 giro a seconda della dimensione del raccordo utilizzato, controllando che il tubo non giri insieme al dado. Si consiglia di utilizzare una chiave dinamometrica e far riferimento alle coppie di serraggio indicate in tabella.

DOPPIO CONTROLLO

7. Al solo scopo di verifica svitare il dado e controllare che l'ogiva abbia inciso in modo uniforme il tubo.

MONTAGGIO FINALE

8. Riavvitare il dado di un 1/4 di giro oltre la chiusura indicata al punto 6.

6. By means of a wrench, tighten the nut by ¼ -1 turn depending upon the fitting size. Avoid any pipe rotation during this phase. For this purpose, it is recommended to use a torque wrench and to refer to the torque force stated in the chart above.

DOUBLECHECK

7. Loosen the nut and make sure that the ferrule has left an even groove on the pipe.

FINAL ASSEMBLY

8. Tighten the nut by ¼ of a turn beyond the number of turns stated at point 6.

6. Serrer l'écrou +/- ¼-1 tours à l'aide d'une clef adéquate selon la taille du raccords et éviter la rotation du tube pendant le serrage. On conseille une clef dynamométrique et de se référer aux couples de serrage indiqués ci-dessus.

CONTRÔLE

7. Pour raison de sécurité, dévisser l'écrou et vérifier que la bague ait bien gravé d'une façon uniforme le tube.

MONTAGE DEFINITIF

8. Visser l'écrou ¼ de tours au delà du point de serrage indiqué au point 6.

6. Mit einem Schlüssel, die Überwurfmutter um ¼-1 Umdrehungen je nach der Verschraubungsgröße weiterziehen. Dafür wird ein dynamometrischer Schlüssel empfohlen und auf die oben genannt Drehmomente, Bezug nehmen. Die Rotation des Rohres muss dabei vermieden werden.

KONTROLLE

7. Aus Sicherheitsgründen, die Überwurfmutter wieder lösen und überprüfen, dass dieselbe eine uniforme Gravur rund um das Rohr hinterlassen hat.

ENDMONTAGE

8. Überwurfmutter um ¼ Umdrehungen über das, beim Punkt 6. angegebene Drehmoment, festziehen.

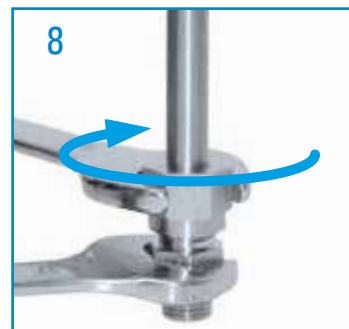

OX 10

Dado

Nut

Écrou

Überwurfmutter

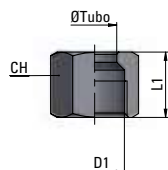

Type	Ø Tubo	D1	L1	CH	g Δ
10 00 04	4	M8x1	11	10	4,3
10 00 06	6	M10x1	11,5	12	5,6
10 00 08	8	M12x1	12	14	7,1
10 00 10	10	M16x1,5	15,5	19	18,4
10 00 12	12	M18x1,5	15,5	22	25,8

OX 11

Diritto maschio conico

Taper straight, male

Union simple mâle conique

Gerade Einschraubverschraubung, kegelig

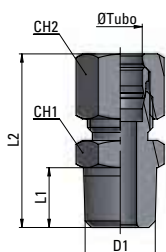

Type	Ø Tubo	D1	L1	L2	CH1	CH2	g Δ
11 04 18	4	R1/8	8	27	10	10	12,9
11 06 18	6	R1/8	8	27	11	12	14,9
11 06 14	6	R1/4	11	31	14	12	24
11 08 18	8	R1/8	8	29	12	14	17,5
11 08 14	8	R1/4	11	32	14	14	25
11 10 14	10	R1/4	11	35,5	17	19	42,4
11 10 38	10	R3/8	11,5	37	17	19	51,2
11 12 38	12	R3/8	11,5	37	19	22	59,3
11 12 12	12	R1/2	14	40,5	22	22	81,1

OX 13

Diritto femmina

Female straight

Union simple femelle

Gerade Aufschraubverschraubung

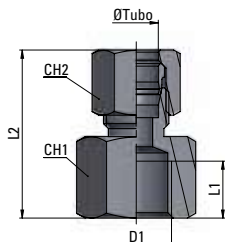

Type	Ø Tubo	D1	L1	L2	CH1	CH2	g Δ
13 06 18	6	G1/8	8,5	28	14	12	20,5
13 08 14	8	G1/4	10,5	31	19	14	35,1
13 10 14	10	G1/4	10,5	34,5	19	19	51,6
13 10 38	10	G3/8	10,5	36,5	22	19	-
13 12 38	12	G3/8	10,5	36,5	22	22	70,2
13 12 12	12	G1/2	12,5	37,5	24	22	69,2

OX 14

Gomito maschio conico

Taper elbow fitting, male

Raccord à coude mâle conique

Winkelverschraubung, kegelig

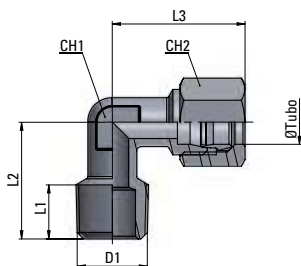

Type	Ø Tubo	D1	L1	L2	L3	CH1	CH2	g Δ
14 04 18	4	R1/8	6,5	17	23	10	10	16,7
14 06 18	6	R1/8	6,5	17	24	10	12	19,2
14 06 14	6	R1/4	10	21,5	24	10	12	21,9
14 08 14	8	R1/4	10	21,5	24,5	10	14	23,1
14 10 14	10	R1/4	12,5	24,5	30,5	12	19	46,8
14 10 38	10	R3/8	11,5	24,5	30,5	12	19	49,8
14 12 38	12	R3/8	12,5	25,5	33	17	22	72,5
14 12 12	12	R1/2	13,5	30	35	19	22	91,2

OX 20

T centrale conico

Taper male tee

T mâle, central

T-Einschraubverschraubung

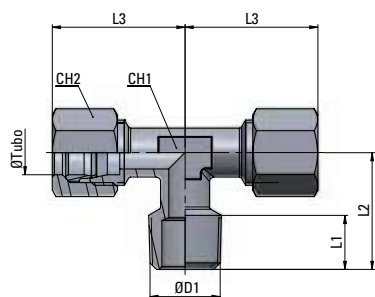

Type	Ø Tubo	D1	L1	L2	L3	CH1	CH2	g Δ
20 04 18	4	R1/8	6,5	17	23	10	10	25,3
20 06 18	6	R1/8	6,5	17	24	10	12	29,6
20 06 14	6	R1/4	10	21,5	24	10	12	32,7
20 08 14	8	R1/4	10	21,5	24,5	10	14	35,1
20 10 14	10	R1/4	12,5	24,5	30,5	12	19	72,6
20 10 38	10	R3/8	11,5	24,5	30,5	12	19	76,9
20 12 38	12	R3/8	12,5	25,5	33	17	22	117,1
20 12 12	12	R1/2	13,5	30	33	19	22	126,2

OX 22

Ogiva

Olive

Bague

Schneidring

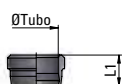

Type	Ø Tubo	L1	g Δ
22 00 04	4	5,5	0,3
22 00 06	6	6	0,8
22 00 08	8	5,7	1
22 00 10	10	8	2,2
22 00 12	12	8	2,5

OX 26

Giunzione intermedia

Union

Union simple égale

Gerade Verbindung

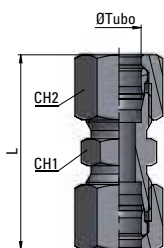

Type	Ø Tubo	D1	D2	L1	g Δ
26 04 04	4	34	9	10	14,9
26 06 06	6	34	11	12	20,4
26 08 08	8	36	12	14	26,5
26 10 10	10	45	17	19	66,4
26 12 12	12	45	19	22	85,8

OX 28

Gomito intermedio

Union elbow

Raccord à coude

Winkelverschraubung

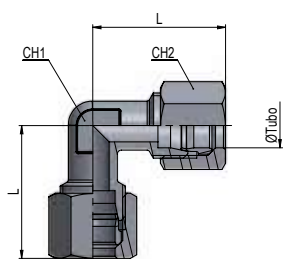

Type	Ø Tubo	L1	CH1	CH2	g Δ
28 04 04	4	23	10	10	21,5
28 06 06	6	24	10	12	25,3
28 08 08	8	24,5	10	14	28,3
28 10 10	10	30,5	12	19	66
28 12 12	12	33	17	22	99,2

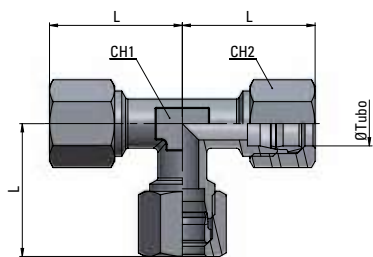

Type	Ø Tubo	L1	CH1	CH2	g ΔΔ
29 04 04	4	23	10	10	30,2
29 06 06	6	24	10	12	36,2
29 08 08	8	24,5	10	14	40,9
29 10 10	10	30,5	12	19	94,1
29 12 12	12	33	17	22	143